

BOX DETAIL SHEET FOR DUMP TRUCKS

CONTACT INFORMATION

NAME _____
 ADDRESS _____
 CITY _____ STATE _____ ZIP _____
 PHONE _____ FAX _____
 BOX/TRAILER MAKE _____

PROVIDE ALL REQUESTED INFORMATION OR YOUR ORDER MAY BE DELAYED.
DO NOT USE UNIVERSAL BOX SIZES. **ALWAYS** USE ACTUAL MEASUREMENTS.

BOX DIMENSIONS

A _____ UPPER BOX LENGTH
 B _____ UPPER BOX WIDTH Front _____ Center _____ Rear _____
 H _____ SHIELD HEIGHT J _____ UPPER SHIELD WIDTH
 K _____ LOWER SHIELD WIDTH N _____ TOP RAIL WIDTH
 U _____ INSIDE BOX WIDTH X _____ BOX HEIGHT
 U1 _____ PLANK-TO-PLANK WIDTH

CORNER CONFIGURATION | *Must select one - see Figure 1*

SQUARE DIAGONAL RADIUS

C _____ OUTSIDE CORNER RADIUS | *For all radius fronts*
 E _____ FLAT ACROSS FRONT
 V _____ FLAT ACROSS DIAGONAL
 W _____ DIAGONAL DEPTH

TARP RAIL STYLE | *See Figure 2*

SQUARE SELF CLEANING SQUARE W/PLANKS*

*Are planks flush with outside of top rail? Y / N (*Circle one*)

CAB SHIELD STYLE | *See Figures 3 and 4*

FLAT RAISED WITHOUT CAB SHIELD

A _____ UPPER BOX LENGTH AJ _____ CAB GUARD DEPTH
 AC _____ REAR BOW DEPTH Z _____ CAB GUARD HEIGHT
 O _____ TOP RAIL DROP Front _____ Rear _____

FRONT BODY STYLE | *See Figure 5*

1-SIDE/CUT-OUT SHIELD 3/4 RAISED SHIELD
 TAPERED CAB SHIELD FULL CAB SHIELD

AG _____ CAB GUARD WIDTH H _____ SHIELD HEIGHT
 AH _____ INSIDE CAB GUARD WIDTH
 AJ _____ CAB GUARD DEPTH J _____ UPPER SHIELD WIDTH
 B _____ UPPER BOX WIDTH Z _____ CAB GUARD HEIGHT

REAR DUMP STYLE | *See Figure 6*

OVERSLUNG HINGE GATE COMBO DOOR HINGE GATE
 HIGH POWER LIFT GATE RAISED HINGE GATE

AF _____ HINGE DEPTH AK _____ HINGE HEIGHT
 B _____ BOX WIDTH/REAR

TARP WEIGHT

18-OZ. 22-OZ.

TARP COLOR(S) _____

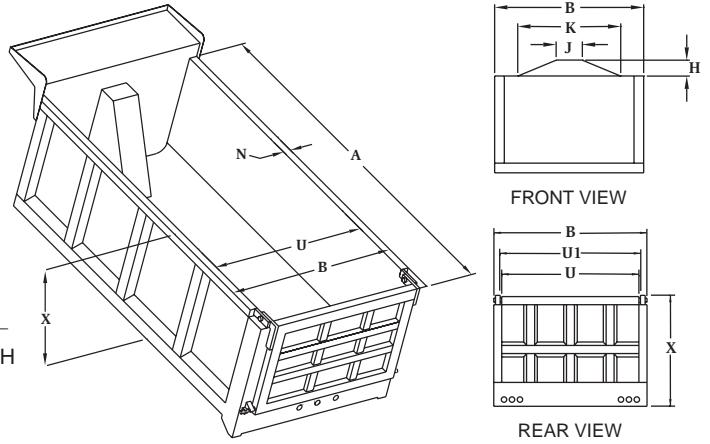

FIGURE 1

FIGURE 2

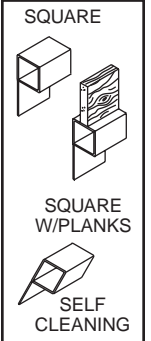
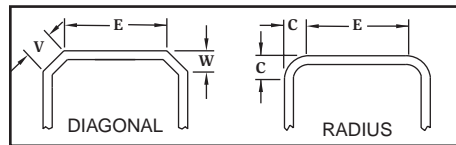

FIGURE 3

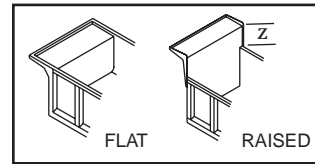

FIGURE 4

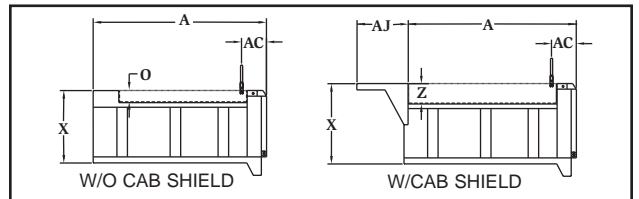

FIGURE 5

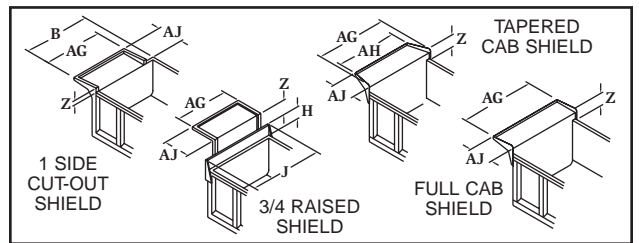
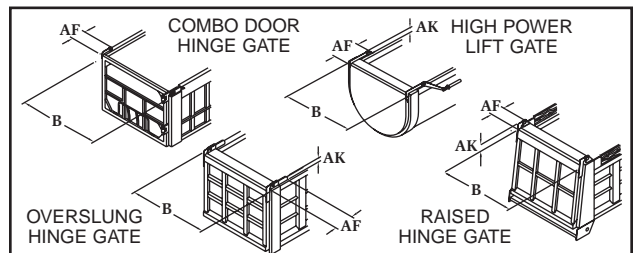

FIGURE 6



fax 605.665.0501

Salesperson _____