

ORDER FORM

Correct measurements are crucial to getting the right tarp fit. Provide all requested information or your order may be delayed. **DO NOT** use universal box sizes. **ALWAYS** use actual measurements.

CUSTOMER ID# _____ PO# _____ DATE _____ SOURCE CODE _____

NAME _____

ADDRESS _____ EMAIL _____ PHONE _____

CITY _____ STATE _____ ZIP _____

END USER ORDER SHIP TO _____

DEALER ORDER

4500 HD FOR END DUMP

EQUIPPED WITH GATE FLEX™ OPTION TO ACCOMMODATE END DUMP DOORS.

MAKE _____

YEAR _____

FRONT OF TRAILER

- VERTICAL SLOPED

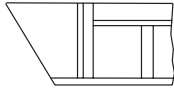
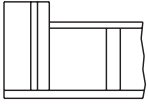

REAR OF TRAILER

- TOP HINGE

(Must be level with or below the top rail.)

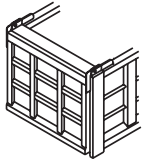

REAR HINGE DEPTH

- 0" - 10"
 >11" - 17"

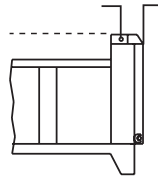

MANUAL OVERRIDE*

- YES NO

*Recommended for hinge depth greater than 2".

QTY OF ELECTRIC WIRE

- 75' 100'

OPERATION TYPE

- ROCKER SWITCH
 SHURLINK PRO™ REMOTE
 SHURLINK EZR™ REMOTE

ADDITIONAL ITEMS TO ASK ABOUT

Are existing roll tubes in good shape? Need easy-off 6" offset tarp stops? Replacement U-clamps and screws?

Will fit these trailer styles:

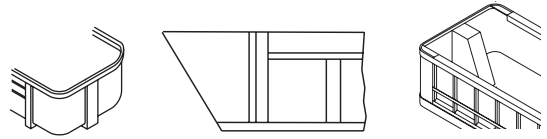

These styles need modification in order to operate properly.

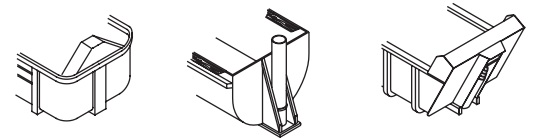

4500 HD FOR LIVE BOTTOM

MAKE _____

YEAR _____

FRONT OF TRAILER

- VERTICAL SLOPED

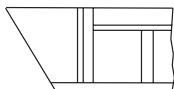
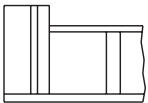

REAR OF TRAILER _____

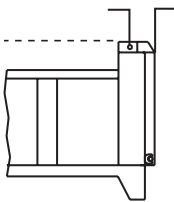

RIB SPACING

FRONT _____ REAR _____ **

**Measure from center of rib to center of rib.

CATWALK LENGTH _____

LOCATION OF LADDER

- U.S. DRIVER U.S. PASSENGER
 CENTER OFF-CENTER

TRAILER MODEL

- 2006 OR NEWER
 2005 OR OLDER

BACK CAP CHOICE***

- ALUMINUM FABRIC CAP

***Recommended for hinge depth greater than 2".

OPERATION TYPE

- ROCKER SWITCH
 SHURLINK PRO™ REMOTE
 SHURLINK EZR™ REMOTE

ADDITIONAL ITEMS TO ASK ABOUT

Are existing roll tubes in good shape? Need easy-off 6" offset tarp stops****? Replacement U-clamps and screws?

****Required for Top Hing Rear Door Kits.

KNIFE GATE

- YES NO

ANGLE

- 45° 57°

KNIFE GATE

- 36" 42" 48" 60"

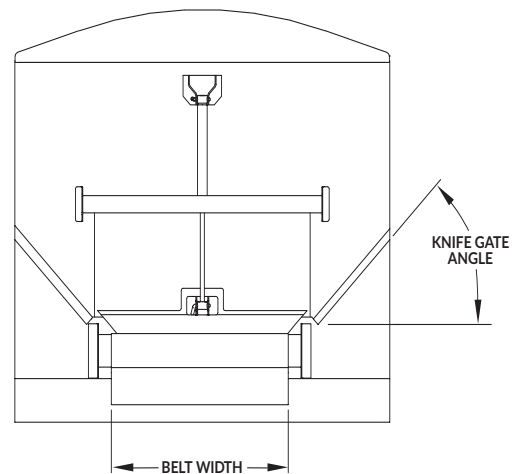

SHUR-CO® SALES REP _____ DATE _____

